

KOOLANCE[®]

Superior Liquid Cooling Systems



Exos-2 User's Manual

English v1.00

Protected by U.S. Patents 6,664,627; 6,313,990; 6,234,240; 5,731,954
Other Technology Pending U.S. & World-Wide Patents

This User Manual is updated regularly. Please be sure to check our support page for a newer version of this guide: www.koolance.com/support

GENERAL PRECAUTION

Please read this manual carefully before beginning the installation of your Koolance system. This manual assumes the user has basic experience in building and configuring computer systems. Information referring to traditional hardware assembly is intentionally brief.

ABOUT SIGNS

Throughout this document, critical information is highlighted in gray-colored boxes. The following symbols are intended to help prevent any situation which may cause personal injury and/or damage to equipment:



WARNING: Indicates a potentially hazardous situation which, if not avoided, could result in personal injury or be life-threatening.



CAUTION: Indicates a potentially hazardous situation which, if not avoided, may result in damage to equipment.



PROHIBITED: Indicates a prohibited action.

PROHIBITED USE

This product is designed, developed and manufactured as contemplated for general use, including without limitation: general office use, personal use and household use, but is not designed, developed and manufactured as contemplated for use accompanying fatal risks or dangers that, unless extremely high safety is secured, could lead directly to death, personal injury, severe physical damage or other loss, including without limitation: nuclear power core control, airplane control, air traffic control, mass transport operation control, life support, or weapon launching control. If these products are used in such hazardous environments, Koolance Incorporated does not warrant them.

TRADEMARKS

The Koolance name and logo, and the Exos name and logo are trademarks or registered trademarks of Koolance, Inc. Other company and product names used in this publication are for identification purposes only and may be trademarks or registered trademarks of their respective companies.

COPYRIGHT

All rights reserved. Copyright (C) Koolance Incorporated



WARNING: The Koolance liquid & coolant pack contain chemicals which may be harmful or fatal if swallowed. KEEP THIS AND ALL DANGEROUS CHEMICALS OUT OF THE REACH OF CHILDREN. If ingestion has occurred, seek medical attention immediately. Give two glasses of water. Do not induce vomiting. In the case of eye contact, flush eyes immediately with water for 15 minutes. Remove contact lenses. Call a physician if irritation persists. Some individuals may have an allergic skin reaction with the solution, although generally mild. Avoid contact as much as possible, and wash exposed area with soap and water for at least 15 minutes. If irritation persists, or if contact has been prolonged, get medical help. For further information, please visit our website at: www.koolance.com



CAUTION: Koolance Incorporated can not be held responsible for any damage to your system due to misconfiguration or incorrect installation. If there is any point of installation that you do not understand, please contact our Technical Support Staff at: tech@koolance.com, or visit our website at: www.koolance.com/support



CAUTION: Liquid cooling systems are not yet universally supported by hardware manufacturers. In some situations, adding liquid coolers and other components to computer hardware might void the manufacturer's original warranty. Installation of the device is ultimately done at the user's own risk. If you have any specific questions on warranty coverage, please contact your component or computer manufacturer.

KOOLANCE CONTACT INFORMATION

Koolance Incorporated (USA)

Address: 1111 344th St. Ste. 202, Federal Way, WA, USA 98003
Telephone: +01-253-839-8999
Fax: +01-253-839-3307
Sales Email: sales@koolance.com
Tech Email: tech@koolance.com

Table of Contents

Introduction	1
Exos-2 System Diagram	4
LED Display Panel	5
Connecting Exos-2 Systems	7
Positioning the Exos	8
External Nozzles & Power Cable	9
Connecting the Slot Adapter	10
Installing the Slot Adapter	11
Power Connection.....	12
ATX Power Switch	13
Cooler & Tubing Configuration.....	14
Disconnecting Hoses	16
Hose Lengths.....	17
Filling & Maintenance	19
Testing & Filling.....	20
Draining & Maintenance.....	22
Troubleshooting	23
Limited Warranty.....	26

Included Hardware

Exos-2 Series Systems:

- External Power Cable
- Slot Adapter
- Rubber foot pads
- ATX power jumper wire
- refill funnel
- liquid coolant mixture
- liquid tubing
- user manual

Required Tools

During installation, you may need the following tools:



flat-head screw driver



phillips-head screw driver



pliers



long-nose pliers



scissors



CHAPTER 1

Introduction

Congratulations on your purchase of a Koolance system!

As the most sophisticated product of its kind, Koolance offers many unique features found nowhere else in the realm of computer cooling. In addition, you can expect to enjoy all of the advantages that water-cooling technology brings with it.

Advantages of Water Cooling

Water transfers 30 times faster, and holds over 4 times more heat than air. With this thermal conductivity and specific heat capacity, it's easy to see why liquid cooling is getting a lot of attention from hardware manufacturers.

Heat-producing devices in a typical computer are cooled by air. Generally, this involves mounting a heat sink and fan to each component. For example, heat generated from your CPU (or other heat source) is transferred into a metal heat sink, where a fan blows air across its wide surface area.

While altering a heat sink's size and makeup can improve the effectiveness, it is still limited because air absorbs and transfers heat very slowly. To help compensate for this, the fan is often run at a higher speed. Many people have therefore come to equate high performance with high noise. As systems continued to be upgraded, the required heat sinks simply got larger and louder.

Liquid cooling greatly reduces the noise issue. A larger amount of heat is withdrawn from the components more quickly, and less airflow is required to cool them.

The heat exchanger is also located remotely from heat-producing devices, so airflow can be controlled. This considerably reduces dust accumulation on sensitive hardware and can result in a **cleaner overall system**.

Advantages of Koolance Systems

Koolance is the first company to offer fully-integrated, consumer-level PC liquid cooling systems to the world-wide market. Our products are designed and **built to look and operate professionally**. You will not need power tools or a tape measure to install your Koolance system, and it should even be less difficult than assembling your own computer.

Koolance offers liquid coolers for every major hardware device. Providing enormous flexibility, you can customize your system to fit your specific needs— cool dual processors in a server, multiple hard drives in a RAID configuration, or add video cooling to a gaming rig.

The heart of a liquid cooling system is the pump. This device pushes liquid through each cooler and into the heat exchanger. Koolance systems use **dual pumps to increase reliability and liquid pressure**. If one pump should fail, the second can help prevent potential damage caused by heat increase.

Every Koolance system **includes built-in hardware safety features**. Our proprietary power control board constantly monitors liquid temperature, sounding an alarm if it should get too high, and even turning off your computer if you are not there to do so.

But Koolance's innovations extend beyond just cooling features. Our **safe, patent-pending CPU Retention Clip** places even pressure across the CPU, protecting the chip and simplifying installation. There's even a ratcheting tension screw for precise contact pressure.

Finally, Koolance systems allow coolers to be **easily exchanged and upgraded** to address future hardware compatibility.

Exos-2 System Diagram

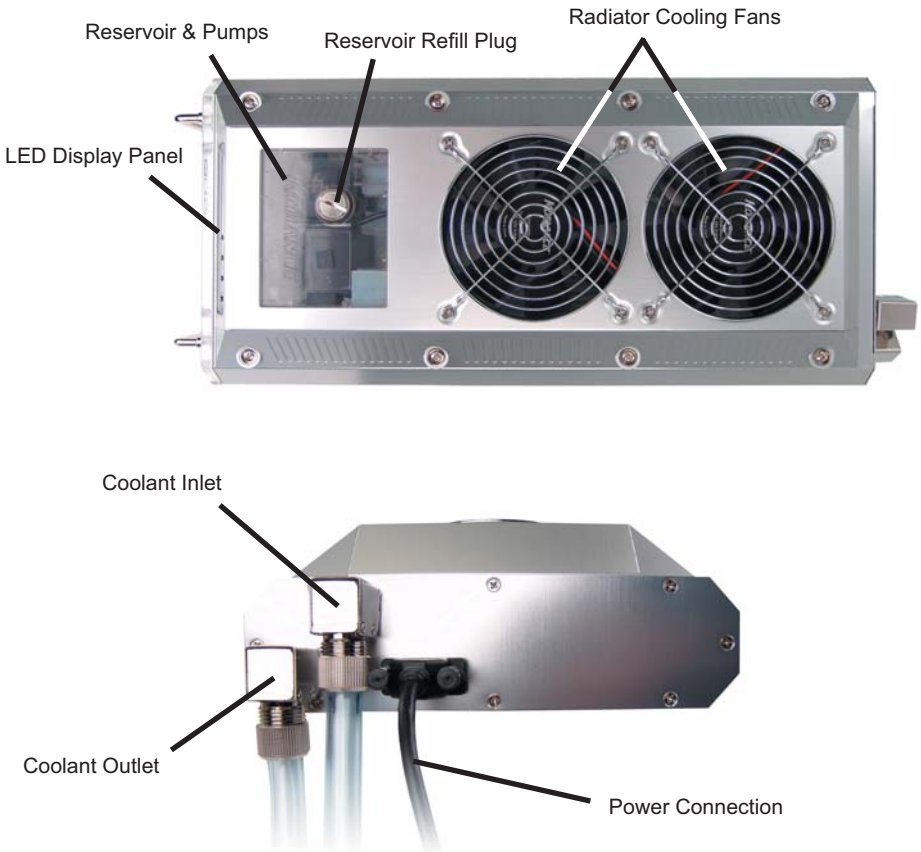

Reservoir & Pumps - The coolant tank is translucent for easy liquid-level monitoring. Dual pumps help to provide higher system reliability; if one pump should fail, the other can maintain flow, gradually bringing the system to shut itself down (see *LED Display Panel*).

Power Circuit Board - Beneath the reservoir, the Power Circuit is responsible for a number of tasks, including: powering the pumps, LED display, heat exchanger fans, and operating the audio alarm and shutdown modes.

Radiator - The primary heat exchanger is located beneath the fan cooling module. This is the main cooling element, and provides high thermal dissipation in a relatively small area. Inside, an aluminum mesh (Louver fin) is webbed between horizontal liquid paths.

LED Display Panel



CAUTION: Exos-2 systems allow full user control of hardware safety settings, such as audio alarm and shutdown. Please be sure to configure your LED Display Panel properly, or damage to your computer and equipment could result.

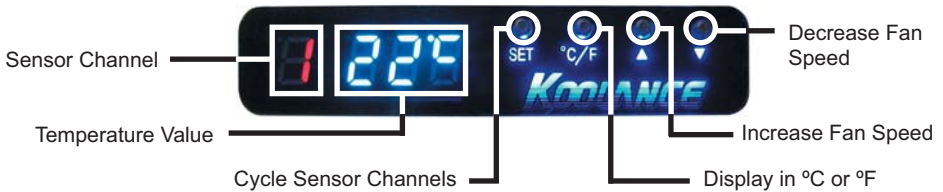

Temperature Sensors

Exos-2 systems can monitor up to 3 temperature sensors (included). The first LED digit indicates which sensor channel is currently displayed in the temperature reading. To cycle through sensors, press **SET**.

Fan Speed

This option adjusts the radiator fan speed. Higher speeds can improve performance, but will produce more noise. There are 1 automatic and 10 manual fan settings (1-10). Press the **▲** or **▼** buttons to cycle through these settings, or hold down an arrow to skip to the highest or lowest mode directly.

Automatic mode will adjust the fans for you based on temperature values from sensor #1. This mode is reached by lowering the fan setting to "0" (**Aut / A1** will be displayed). Details on fan modes are as follows:

Auto Mode	Manual Mode	Fan Power %	Total CFM	Fan RPM
0 - 35°C (32 - 95°F)	1	30	56	720
36 - 37°C (97 - 99°F)	2	35	66	840
38 - 39°C (100 - 102°F)	3	40	75	960
40 - 41°C (104 - 106°F)	4	45	85	1080
42 - 43°C (108 - 109°F)	5	50	94	1200
44 - 45°C (111 - 113°F)	6	60	113	1440
46 - 47°C (115 - 117°F)	7	70	132	1680
48 - 49°C (118 - 120°F)	8	80	150	1920
50 - 51°C (122 - 124°F)	9	90	169	2160
52 - 99°C (126 - 210°F)	10	100	188	2400

Alarm Settings

By default, the Koolance audio alarm will sound if any sensor reaches 55°C (131°F). When the system alarm sounds, the LED temperature will flash in the display and the radiator fans will increase to 100% power.

To change this setting for an individual sensor, choose the desired channel with **SET**, and press and hold ▲ + ▼ together for 3 seconds. The alarm temperature will begin flashing. You may change this value from 0°C (32°F) up to 99°C (210°F). The normal temperature reading will resume if you do not press any buttons for 4 seconds.

To reset all temperature alarms to their default (55°C / 131°F) setting, press and hold the °C/F button until “dEF” flashes in the display. NOTE: This will also reset the fan speed mode to “auto”.



CAUTION: Although alarm settings can be set separately for each sensor, safety shutdown mode will only respond to sensor #1. It is highly recommended for this sensor to be metal-taped to the CPU Cooler cold plate (*not between* the processor and cooler), and set no higher than 55°C (131°F). Please see your CPU Cooler instructions for information on attaching the temperature sensor.

Safety Shutdown

If the temperature value of sensor #1 reaches 3°C (5°F) above the alarm temperature, the system will shutdown power to the computer. With default alarm settings, this means the system would shutdown if sensor #1 reached 58°C (136°F).



CAUTION: If activated, the shutdown feature of your Koolance system will automatically turn off power to the entire computer. Unsaved files and documents may be lost. Always make regular backups of your files to an external device or medium.

CHAPTER 2

Connecting Exos-2 Systems

Positioning the Exos

The Exos is designed to operate in various locations, but it must run upright. Air filtration is not possible in all orientations.

If the Exos can not be placed adjacent to the computer, it can be moved farther away. Depending on heat load, 3-6 feet (1-2 meters) should be an acceptable distance for most Exos configurations.

Extra tubing can be purchased from Koolance.com or your local reseller.



Rubber foot pads are included to place the Exos on or near your computer chassis. If you are frequently transporting your computer system, an optional “Exos Attachment Belt” straps the unit to your computer chassis via the metal foot loops underneath the unit.



Rubber Foot Pad



Attachment Belt

External Nozzles & Power Cable



Cut the included 10mm (3/8") tubing into two segments. You will need to connect each to the Exos' rear nozzles.

Each tubing connection uses a threaded compression fitting ("hose screw") to keep it secure. To connect these components, first thread a hose screw onto the tube end.



Squeeze the tube while pushing it firmly over the nozzle. Tubing should completely cover the nozzle.

Tighten the connection by sliding the compression fitting down over the nozzle and screwing securely.



Once the hoses are connected, plug the external power cable into the Exos.

Connecting the Slot Adapter

The Slot Adapter allows the Exos-2 to connect with any ATX computer through an available card slot. It is responsible for both input and output tubes, along with the external power cable connection. This prevents the computer chassis from requiring any modifications for the cooling unit.

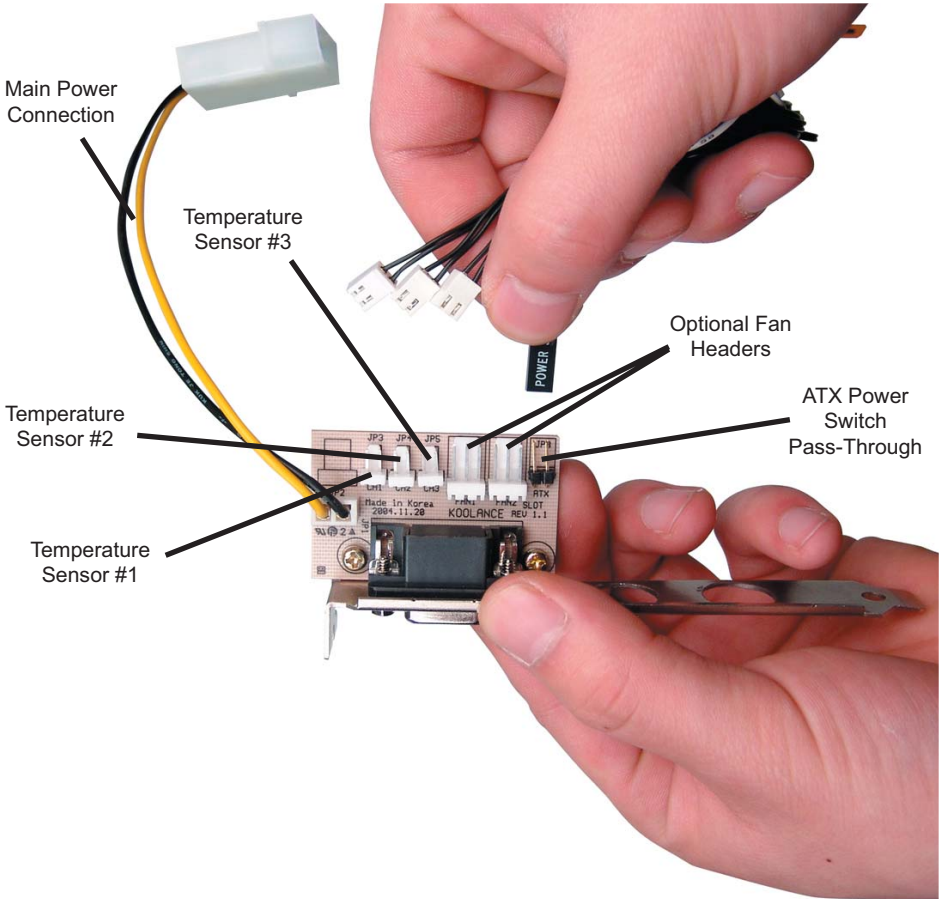

There are 5 main internal connections to the Slot Interface card which will be made. The Exos-2 may appear to operate without some of these connections, but hardware safety features or temperature monitoring might be deactivated.

Start by connecting Temperature Sensors #1, #2, and #3. Then connect the ATX Pass-Through wire.

Installing the Slot Adapter

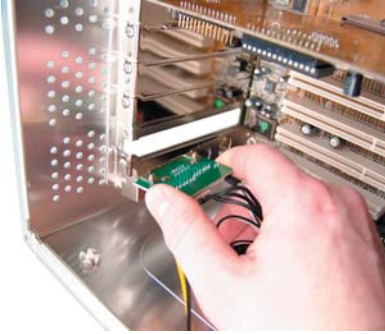

Install the Slot Adapter into any available rear card slot in your computer.



Screw the Slot Adapter in place as you would a normal device.

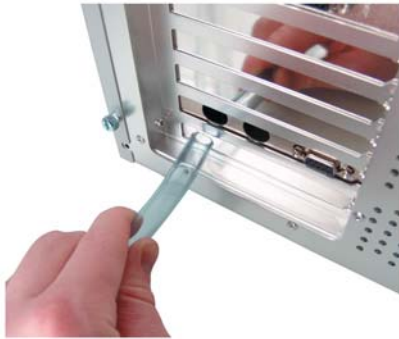

From the rear of the case, carefully feed both ends of the liquid tubing through the Slot Adapter and into the chassis.

Plug the other end of the Exos' external power cable into the Slot Adapter.



Power Connection

The Exos-2 requires approximately 11-17W from any standard ATX power supply. Since it is adapted internally, it does not need a dedicated external AC power cable.

Connect the Slot Adapter's main power plug (12 Volt 4-pin Molex) to the computer's power supply. Without this important connection, the Exos-2 will NOT operate.

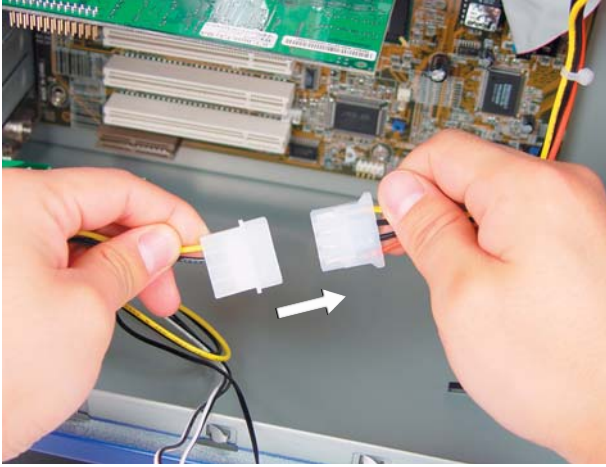

CAUTION: The Power Connection is vital to system operation. A 12V 4-pin plug from the power supply must remain connected to the cooling system at all times while the computer is in use.

ATX Power Switch

The ATX “pass through” lead is responsible for shutting off your computer if sensor channel #1 reaches 3°C (5°F) above the preset alarm temperature (See *LED Display* for alarm configuration).

Connect the male ATX power lead from the Slot Adapter to the chassis main power button.

To Motherboard

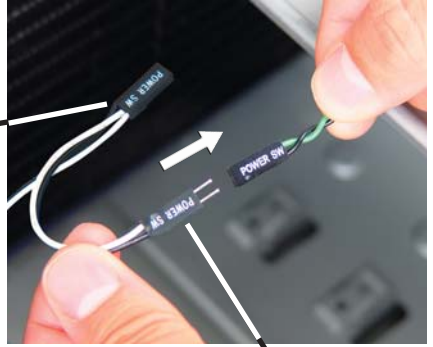

To ATX Power Button

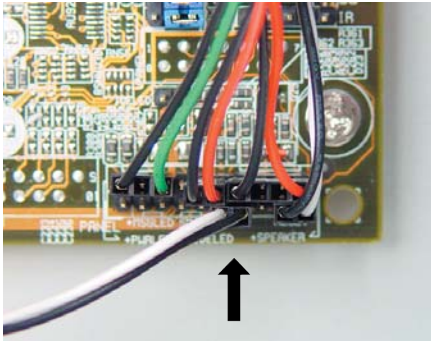

Connect the female ATX power lead from the Slot Adapter to the motherboard's power switch connection (often marked “PWRSW”, “PSW”, or “PWBT”).

This is the connection that would normally receive the chassis power switch lead directly.



CAUTION: The auto shutdown safety features of your Exos-2 will not function properly without connecting the ATX power switch lead.

Cooler & Tubing Configuration

Depending on the cooling blocks (“coolers”) in your Koolance system and nozzle sizes (1/4”, 3/8”, etc.), they may be connected in series, parallel, or a mixture of both for best performance. Recommended configurations are illustrated below.

If you are comfortable experimenting with different tubing setups, there may be more optimal configurations for your particular system.

NOTE: For simplicity, tubing ID (internal diameter) will be listed in metric units. Please use these approximate conversions for Imperial sizes:

Metric	Imperial
6 mm	1/4 in.
10 mm	3/8 in.
13 mm	1/2 in.

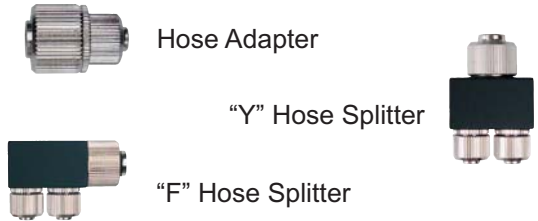

Series Systems

For systems with only CPU coolers, a simple series loop will provide the best performance.

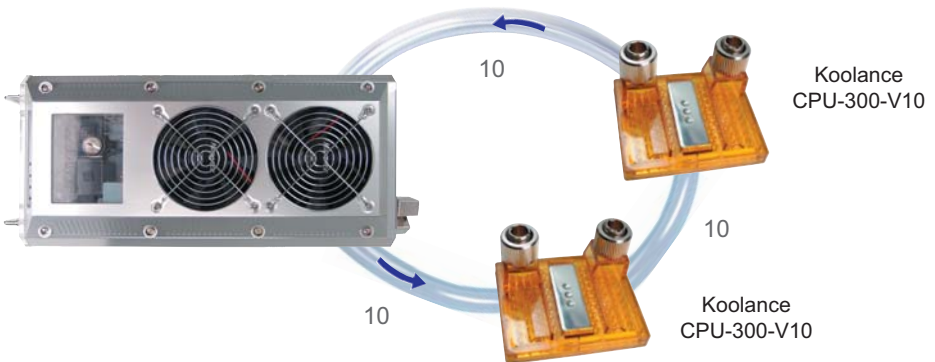
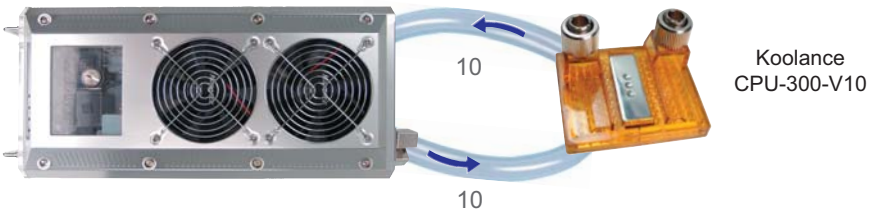

Parallel Systems

Koolance coolers which are 6mm (1/4"), such as the GPU-180-L06 video cooler or HD-40-L06 hard drive cooler, can still be effectively used in Exos-2 series systems. Using a parallel tubing configuration with hose splitters will help maintain coolant flow rate through these systems.

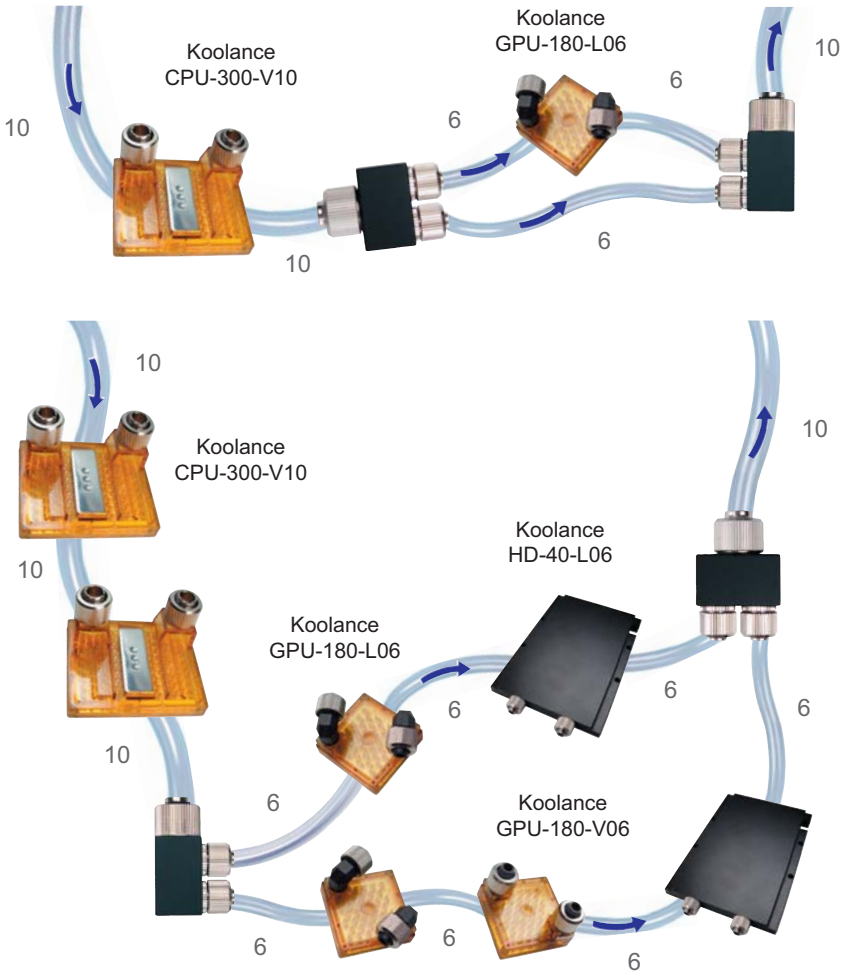

The maximum number of coolers allowed in a system will depend upon your specific thermal requirements and hose configuration. It is not uncommon to see five or more coolers in a Koolance system, but the limit is usually at what temperature you are comfortable with. Remember, liquid at higher temperatures is still considerably more effective at carrying heat than air at the same temperature.

Disconnecting Hoses

Nozzles are designed to attach tightly. If you need to remove a hose for any reason, it may not pull off easily, even after unscrewing the compression fitting.

Usually, a connection will come free by squeezing the hose *on top of* the nozzle and pulling away. If this fails, cutting a small incision lengthwise (parallel) along the nozzle should free it.

When a hose screw has been removed, it may have distorted the tubing beneath it. This last portion (about 1cm, 7/16") should be trimmed to ensure a perfect fit with the next connection.

The tip should *always* be re-cut if you needed to remove the tubing with an incision.



Hose Lengths

Before installing your liquid coolers, appropriate lengths of tubing must be cut to connect each device. It is generally easier to estimate the required tubing amounts with installed computer hardware.

On the rear of the Exos, the nozzle to the left is the outlet of the radiator. The right nozzle is the inlet. Generally, the outlet will connect first with your CPU Cooler.

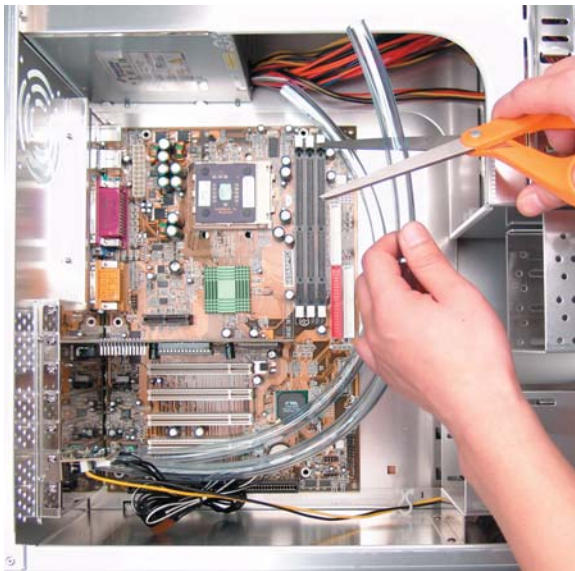
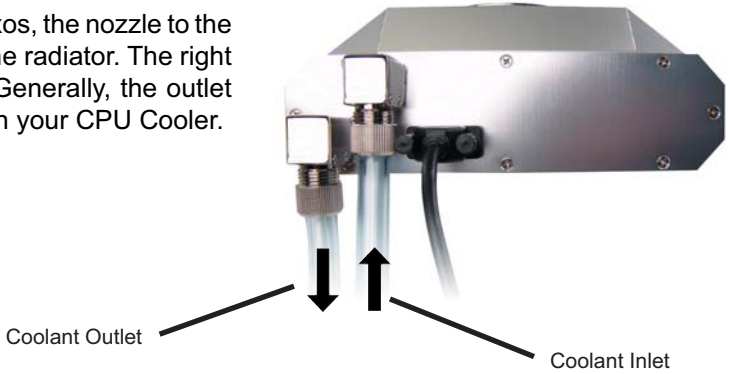

With the connected outlet hose, roughly estimate the length you will need to your first cooler, and cut it.

Cut the second hose with enough length to connect with the last cooler that will be in your system.

Using the leftover tubing, cut shorter pieces to link between each individual cooler.



Continue connecting all of your coolers in the system until there are no longer any open tube ends.

Liquid Coolers

You should now install the liquid coolers (CPU, GPU, Hard Drive, etc.) to your hardware before continuing this User Manual. Please refer to your cooler kit's individual installation instructions, then continue on to the next section.

CHAPTER 3

Filling & Maintenance

Testing & Filling

 Once all of the coolers have been connected, the system can be filled with coolant. The refill plug is located on top of the reservoir. Remove the large slot-headed screw (with a screwdriver or large coin) and insert the refill funnel.



WARNING: The liquid coolant is electrically conductive. Use caution when filling the system, and keep all liquids away from computer hardware and power cables. In case of emergency during installation, immediately unplug the computer's rear power cable. Dry the system thoroughly before proceeding.



Cut a very small corner in the coolant pack, and slowly fill the reservoir. You may not require the whole pack of liquid.



The liquid coolant should be filled up to about 1.5 cm (1/2") from the reservoir's top. This small gap will catch air as it circulates through the system. **Do not overfill.** It is recommended to keep paper towels on hand just in case.

Because of gravity, the Exos must be placed above all internal cooling components while being filled. Otherwise, coolant will exit the refill tap once the reservoir is full.



CAUTION: When filling, the Exos must be higher than all internal liquid coolers, or coolant will exit the refill tap upon filling.



Replace the refill plug screw.

The cooling system can be “jump-started” to assist in the circulation process without booting-up the computer. This will also allow you to check your hose connections and make sure there are no folds in the tubing.



CAUTION: Jumping the incorrect ATX power supply pins can cause permanent damage to the power supply.

Make sure the AC power cord is attached to the power supply. If the power supply has a rear switch, it must be in the ON (-) position. Using the ATX Jumper Wire, insert the metal prongs into the **fourth and sixth** connectors on the 20 pin motherboard ATX power supply connector (usually green and a black ground wire; See *diagram*).

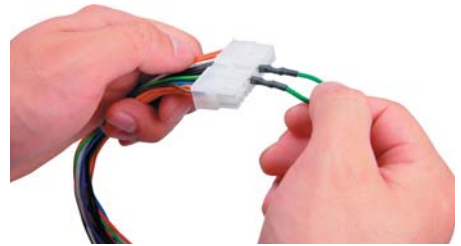
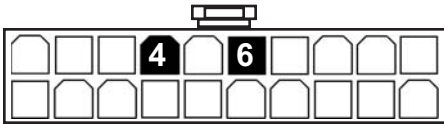

Allow the pumps to run for about 1-5 minutes. When filtration has ended, the liquid noise should stop. If the reservoir level becomes significantly lower during this “bleeding” process, add more liquid coolant. (In the future, if you begin to hear liquid rushing through the reservoir, it may indicate more coolant needs to be added.)

That's it! Replace the ATX motherboard connection and boot-up the computer.

Draining & Maintenance

The coolant in your system should be emptied for any of the below reasons. Unless replacing the liquid coolant, it can also be reused.

1. To Keep it Clean - Koolance recommends replacing the liquid coolant about every 2 years. The coolant should also be replaced if it becomes contaminated or significantly changes color.

2. Upgrading Coolers - Whether you are adding or removing liquid coolers, upgrades can be performed more easily with a dry system.

3. Shipping - For safety, Koolance recommends draining the liquid coolant if the system is to be shipped or transported in a method other than by hand.



Before draining the system, it should be placed upright on a table with the bottom refill tap overhanging. Hold a 2 liter container below the reservoir to capture liquid. Unscrew the refill tap to begin draining the system.

In some configurations, air may not be able to enter the system and will prohibit coolant from draining. If this occurs, you can remove tubing from the highest cooler within the chassis to relieve the liquid.

NOTE: This may result in spillage and should not be done with installed computer hardware or a power supply.



CAUTION: Because of the possibility of leakage, computer hardware should first be removed before draining your system if done so by hose disconnection.

Radiator Performance

Over time, dust will accumulate on the radiator. While the cooling system may continue to operate in this condition, performance can decrease. To keep the system clean, check the radiator periodically (through the top fan grill) and use a can of electronics air cleaner if necessary.

Troubleshooting

Your Koolance system is designed to provide years of reliable cooling. To help avoid unnecessary product returns, we have prepared this list of possible operational problems, and their most common solutions.

1. How do I tell if the pumps are working?...

After initial air-filtering, the pumps may not create enough noise to tell if they're working properly. During normal operation, some air bubbles may even remain attached to the insides of the hoses and will not appear to move when the tubing is "flicked".

The easiest way to test pump operations is to simply monitor liquid inside the reservoir. If the pumps are operating, liquid movement should be visible.

2. My temperatures seem too high...

Unless your processor is capable of reading temperatures within the die, BIOS temperatures may not provide reliable readings for liquid cooling systems. This is due to the absence of air flow beneath the CPU socket. If the system exhibits signs of high temperature (reboots, shut-downs, etc.), there may be a problem with your system. These same symptoms can also be attributed to a faulty power supply, and other internal hardware.

Verify that the liquid coolers are making sufficient contact with each component. Make sure the CPU tension screw is placed in the correct cooler receptacle (see the CPU Cooler's Instructions). If the thermal interface material has become over-used, or if the protective film on a liquid cooler has not been removed, the system can exhibit higher temperatures or malfunction.

Also check that there are no blocks, twists, or crimps in the tubing system. If a nozzle has been attached inappropriately, it should be reconnected.

Finally, a dusty Radiator can also result in higher temperatures. Please see *Draining and Maintenance* for more information.

3. When I adjust the temperature alarm settings, it skips number increments...

This is normal operation if your LED is set to display in Fahrenheit, because the temperature program is based on whole centigrade units. Some °C values convert to decimal temperatures in °F, or skip over them, and these can not be set by the program.

4. After the system has been on for a while, the temperature alarm sounds...

Make sure the LED temperature is at or above your preset alarm temperature (default is 55°C, 131°F). If not, the audio alarm may in fact be your motherboard's BIOS alarm. If the system is not exhibiting signs of overheating (see #2 in *Troubleshooting*), this temperature monitor may need to be disabled to ignore false readings by BIOS. The Koolance LED temperature will flash whenever the cooling system alarm sounds.

If the alarm sounds within a few seconds after a cold boot-up, or the LED temperature does not reach the alarm preset, the control board/pumps may be malfunctioning. Please visit our support web page for more information.

Verify that the pumps are operating (see *Troubleshooting #1*), and that liquid flow is present in the reservoir. Note that if the reservoir was over-filled during system assembly, this procedure is not possible since there will be no necessary air gap.

5. My system has boot-up problems, or does not turn on...

The majority of these problems are not related to the Koolance case, but hardware or configuration issues. In a new system, a problem with the RAM, motherboard, power supply, video card, processor, or monitor can cause the system to appear not to boot-up properly.

If the top Radiator fans do not spin, or if the front LED Display Panel does not light-up, check to see if your motherboard has a power indicator LED on the board. This is usually a green light next to the ATX power connector. If unlit, power is not getting to the motherboard.

The Power Circuit (or Exos Slot Interface Adapter) should be checked to make sure all connections are plugged-in, especially the 12V 4-pin power supply connection. Also be sure if your power supply has a rear power switch, that it is in the ON ("-") position, and switched to the appropriate regional current (115VAC or 220VAC).

Another possibility is that the motherboard is shorting-out electrically on the chassis. Remove the motherboard, and verify that the stand-offs are properly installed. Lastly, check that the IO shield (the thin aluminum rear motherboard ATX port plate) is not bent backwards around the motherboard, possibly shorting a component.

If further problems persist, you are likely having a separate hardware issue.

6. My system appears to be leaking fluid...

Since users are allowed to configure their own coolers and clamps, it is possible a connection was not properly sealed (however unlikely). If you can see liquid somewhere on the tubing, or at the bottom of the chassis, computer components may need to be removed for a system test (see *Flow Testing*).

If liquid should get onto another computer component, shut down the system, and remove the component. In many cases, the hardware will be fine after allowing it to dry. However, the system should not be operated until you have discovered where the leak is coming from and can repair the problem. Should the leak be situated somewhere in which it can not be easily repaired, please contact our Technical Department for further diagnostic information.

7. My computer's BIOS gives me errors that there are no cooling fans attached...

Some motherboards will not boot, or may generate an error or alarm if no cooling fans are attached to the CPU or motherboard chipset power connectors. There is sometimes an option to disable these fan connections in BIOS, but you may have to boot-up with a fan attached initially to disable this setting. If the system is not booting due to this problem, clear the CMOS and try configuring BIOS again.

8. The LED Display Panel shows "S - 0" or "S - S"...

Your Koolance LED display may specify if there is a problem with the cooling unit. Please use the following guide in determining the cause of a problem:

S - 0 : Sensor open. This indicates that a temperature sensor may be disconnected or faulty. If sensor channel #1 is listed with an "S-0" status, the cooling system alarm will sound because this connection is required. Sensors #2 and #3 are optional connections.

S - S : Sensor short. This indicates that a sensor may be faulty or electrically bypassed. If any sensor channel is listed with an "S-S" status, the cooling system alarm will sound.

9. The LED Display Panel does not light up...

A defective display circuit is extremely rare. Usually, this is due to a misaligned or disconnected plug on the Power Circuit (or Exos Slot Interface Adapter). Verify that all appropriate plugins are attached, particularly the 12V 4-pin power supply connection.

Limited Warranty

Koolance Incorporated (“Koolance”) warrants each new Koolance liquid-cooled system (“the system”), against defects in materials or workmanship for a period of one year from the date of purchase, and agrees to repair or replace any defective Koolance system without charge. Shipping costs are non-refundable.

This warranty is non-transferable. All warranty claims must be accompanied by the original proof of purchase.

THIS WARRANTY DOES NOT COVER DAMAGE RESULTING FROM ACCIDENT, MISUSE OR ABUSE, LACK OF REASONABLE CARE, SHIPPING DAMAGE, MODIFICATIONS, THE AFFIXING OF ANY ATTACHMENT NOT PROVIDED WITH THE PRODUCT, LOSS OF PARTS, OR OPERATING COMPONENTS AT SPEEDS OR FUNCTIONS OTHER THAN THOSE SPECIFIED BY THEIR MANUFACTURERS.

Use of unauthorized replacement parts or liquid additives will void this warranty. Koolance Incorporated will not pay for warranty service performed by a non-authorized repair or diagnostic service and will not reimburse the consumer for damage resulting from warranty service performed by a non-authorized repair service. No responsibility is assumed for any special incidental or consequential damages due to a defective Koolance product.

In order to obtain warranty service, contact our RMA department for information. The product must be shipped postage prepaid to an authorized Koolance service location. It is suggested that, for your protection, you return shipments of product by insured mail, insurance prepaid. Damage occurring during shipment is not covered by this warranty. Shipping costs are non-refundable. No other warranty, written or oral, is authorized by Koolance Incorporated.

Disclaimer

IN NO EVENT SHALL KOOLANCE INCORPORATED OR ITS EMPLOYEES, AGENTS, SUPPLIERS, MANUFACTURERS, OR CONTRACTORS BE LIABLE FOR ANY DAMAGES OF ANY KIND OR CHARACTER, INCLUDING WITHOUT LIMITATION ANY COMPENSATORY, INCIDENTAL, DIRECT, INDIRECT, SPECIAL, PUNITIVE, OR CONSEQUENTIAL DAMAGES, LOSS OF USE, LOSS OF DATA, LOSS OF INCOME OR PROFIT, LOSS OF OR DAMAGE TO PERSONS OR PROPERTY, CLAIMS OF THIRD PARTIES, OR OTHER LOSSES OF ANY KIND OR CHARACTER, AND WHETHER OR NOT THE POSSIBILITY OF SUCH LOSS OR DAMAGE HAS BEEN NOTIFIED TO KOOLANCE INCORPORATED.

KOOLANCE

www.koolance.com

**ISO
9001**

Printed in Korea