



# RP-1250 User's Manual

English v1.01

ISO  
9001

Printed in Korea

This User Manual is updated regularly. Please be sure to check our support page for a newer version of this guide: [www.koolance.com/support](http://www.koolance.com/support)

## GENERAL PRECAUTION

Please read this manual carefully before beginning the installation of your Koolance system. This manual assumes the user has basic experience in building and configuring computer systems. Information referring to traditional hardware assembly is intentionally brief.

### ABOUT SIGNS

Throughout this document, critical information is highlighted in gray-colored boxes. The following symbols are intended to help prevent any situation which may cause personal injury and/or damage to equipment:



**WARNING:** Indicates a potentially hazardous situation which, if not avoided, could result in personal injury or be life-threatening.



**CAUTION:** Indicates a potentially hazardous situation which, if not avoided, may result in damage to equipment or property.



**PROHIBITED:** Indicates a prohibited action.

## PROHIBITED USE

This product is designed, developed and manufactured as contemplated for general use, including without limitation: general office use, personal use and household use, but is not designed, developed and manufactured as contemplated for use accompanying fatal risks or dangers that, unless extremely high safety is secured, could lead directly to death, personal injury, severe physical damage or other loss, including without limitation: nuclear power core control, airplane control, air traffic control, mass transport operation control, life support, or weapon launching control. If these products are used in such hazardous environments, Koolance Incorporated does not warrant them.

## TRADEMARKS

The Koolance name and logo are trademarks or registered trademarks of Koolance, Inc. Other company and product names used in this publication are for identification purposes only and may be trademarks or registered trademarks of their respective companies.

## COPYRIGHT

All rights reserved. Copyright (C) Koolance Incorporated.



**WARNING:** The Koolance liquid & coolant pack contain chemicals which may be harmful or fatal if swallowed. KEEP THIS AND ALL DANGEROUS CHEMICALS OUT OF THE REACH OF CHILDREN. If ingestion has occurred, seek medical attention immediately. Give two glasses of water. Do not induce vomiting. In the case of eye contact, flush eyes immediately with water for 15 minutes. Remove contact lenses. Call a physician if irritation persists. Some individuals may have an allergic skin reaction with the solution, although generally mild. Avoid contact as much as possible, and wash exposed area with soap and water for at least 15 minutes. If irritation persists, or if contact has been prolonged, get medical help. For further information, please visit our website at: [www.koolance.com](http://www.koolance.com)



**CAUTION:** Installation of third-party cooling products is done at the user's own risk. Koolance Inc. assumes no responsibility for damage or loss due to the installation or use of this product. Additionally, adding liquid coolers and other components to computer hardware may void the hardware manufacturer's original warranty. If you have any specific questions on warranty coverage, please contact your component or computer manufacturer. If there is any point of installation that you do not understand, please contact our Technical Support Staff at: [tech@koolance.com](mailto:tech@koolance.com), or visit our website at: [www.koolance.com/support](http://www.koolance.com/support)

## KOOLANCE CONTACT INFORMATION

Koolance Incorporated (USA)

Address: 2840 W. Valley Hwy. N., Auburn, WA, USA 98001  
 Telephone: +01-253-893-7551  
 Fax: +01-253-893-7573  
 Sales Email: [sales@koolance.com](mailto:sales@koolance.com)  
 Tech Email: [tech@koolance.com](mailto:tech@koolance.com)

## Table of Contents

<b>System Features</b>	<b>1</b>
Product Diagram .....	2
Display Panel .....	3
<b>Installation</b>	<b>10</b>
Positioning the Unit .....	11
Reservoir & Pump Connections .....	11
Power Connection .....	12
Fan Connection .....	12
Flow Meter Connection .....	12
ATX Pass-Through Lead .....	13
Temperature Sensor Placement .....	13
Fittings .....	14
Cooler & Tubing Configuration .....	15
Disconnecting Hoses .....	17
Hose Lengths .....	17
<b>Filling &amp; Maintenance</b>	<b>19</b>
Testing & Filling .....	20
Adding Coolers & Maintenance .....	22
Troubleshooting .....	23
Limited Warranty .....	26

## Included Hardware

- Temperature Sensors (x3)
- ATX Pass-Thru Wire
- Mounting screws
- ATX Jumper Wire
- User Manual

## Required Tools

During installation, you may need the following tools:



flat-head screw driver



Phillips-head screw driver



pliers



long-nose pliers



scissors



# Chapter 1

---

## *System Features*

## Product Diagram



**NOTE:** After powering on this unit, wait 5 seconds before powering it off again. Otherwise, the display may lock-up and require reset (hold ▼ + ▲ for 5 seconds.)

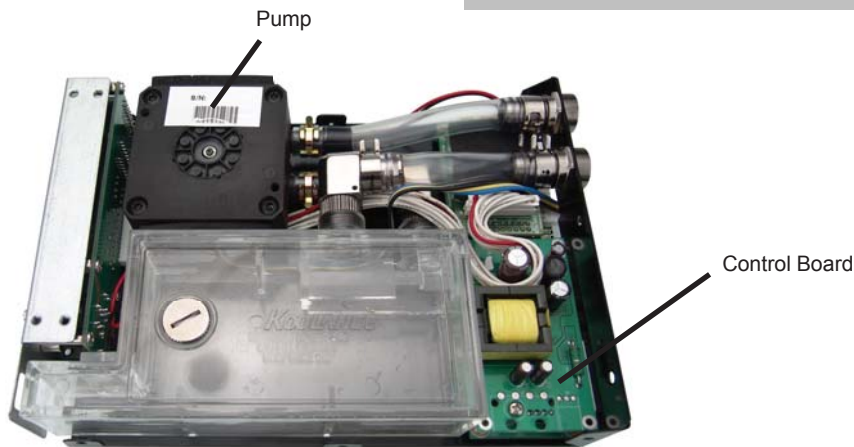

**Reservoir & Pump** - The coolant tank is transparent for easy liquid-level monitoring through the front window. It is filled through a metal fill port on top. The reservoir is illuminated by internal blue LEDs.

**Control Board** - Behind the reservoir, the Control Board is responsible for a number of tasks, including: powering the pump, display, radiator fans (if attached), and operating the audio alarm and shutdown modes.



## Display Panel

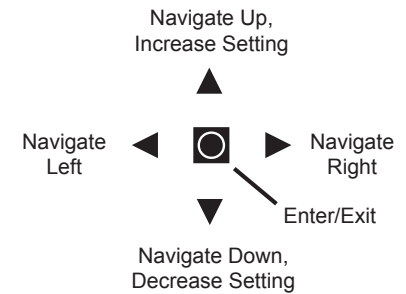

**CAUTION:** This cooling system allows full user control of hardware safety settings, such as audio alarm, shutdown, and pump speed. Please be sure to configure your Display Panel properly, or damage to your computer, data, and/or equipment could result.

The Koolance display panel allows control and monitoring of various aspects of the cooling unit. 4 buttons are used, with directional arrows to navigate or change settings, and a center button to enter/exit.



- On the main screen, hold  for 3 seconds to change display units between °C/°F and LPM/GPM.
- You can exit any menu and return to the main screen by holding  for 2 seconds.
- To reset **ALL** settings to default, hold ▼ + ▲ for 5 seconds.

### Main Menu

To enter the main menu, briefly press . The selected option will begin flashing. Use ▼ and ▲ to navigate this menu.

- ↑ TEMP SET: Temperature, alarm, and shutdown settings
- FAN SET: Fan settings
- PUMP SET: Pump settings
- ↓ FLOW SET: Flow meter settings
- DISPLAY SET: Display settings

When in the top menu, press  to enter one of the above categories. To exit from here, press ◀.

### TEMP SET

The temperature menu allows configuration of the alarm and safety shutdown options. This cooling system can monitor up to 3 (included) temperature sensors. An audio alarm will sound if any sensor reaches its set alarm point. The offending sensor will also flash in the display, and the radiator fans and pump will increase



to 100% power. If any sensor reaches its set shutdown point, the system will shutdown power to the computer via relay using the “ATX pass-through” wire.



```

↑ TEMP1 55C 56C : Sensor #1, Alarm Point, Shutdown Point
↓ TEMP2 51C 54C : Sensor #2, Alarm Point, Shutdown Point
↓ TEMP3 60C 70C : Sensor #3, Alarm Point, Shutdown Point
  
```

When in the “Temperature Settings” menu, the selected temperature sensor will flash. Press ▼ and ▲ to navigate, or press  to select a sensor to configure:

```

TEMP1 SET
AL: 55C PW: 56C : AL = Alarm, PW = Power (Shutdown)
  
```

The alarm value will flash. Press ▼ or ▲ to adjust a value. Press  to change to the shutdown temperature. Press  again to exit configuration of this sensor. Press ◀ to return to the previous menu.

NOTE: The shutdown temperature must be at least 1°C (1-2°F) higher than the alarm temperature. If an alarm temperature can not be increased, increase the shutdown temperature first. The minimum and maximum temperature range allowable is 0-99°C (32-210°F).



**CAUTION:** Generally, sensors report liquid temperature at the water block, which is typically 5-10°C (9-18°F) lower than the actual heat source. This difference must be considered if adjusting alarm/shutdown temperatures. Setting alarm/shutdown modes at too high of temperature can eliminate this feature’s effectiveness. The default Koolance settings are designed to help compensate for differences in temp.

## FAN SET

This unit has three fan channels which can be independently adjusted. Alternatively, use the master fan channel (“ALL FANS”) to adjust all fan channels simultaneously.

```

↑ ALL FANS 50% : All Fans (Master), Speed Setting %
↓ FAN1 SET 84% : Fan Channel #1, Speed Setting %
↓ FAN2 SET 47% : Fan Channel #2, Speed Setting %
↓ FAN3 SET 30% : Fan Channel #3, Speed Setting %
  
```

The selected fan channel will flash. Press ▼ and ▲ to navigate, press ◀ to return to the previous menu, or press  to configure this fan channel:

```

ALL FANS 50%
  
```

The speed value will flash. Press ▼ or ▲ to adjust this value. Press  to confirm the setting.

Higher fan speeds can improve performance, but will produce more noise. Fan speeds can be adjusted manually from 0-100%.



**CAUTION:** Fan percentages are based on PWM duty. Fans will not operate if set too low. Some types of fans may also not be compatible with the PWM program and will only operate reliably at 100%.

Instead of manual speeds, fans can also be set to automatic. This is highly recommended, since speeds will change based on temperature sensor feedback. This is a good way to keep noise levels to a minimum while allowing the cooling system to respond to temperature. To set a fan channel to automatic, press ▲ past 100% until “AUTO” is shown:

```

ALL FANS AUTO
  
```

From here, press  to configure the automatic mode:



```

ALL FANS AUTO
T1 L45C H80C : Temp Sensor, Low Point, High Point
  
```

The number following “T” designates the temperature sensor this fan channel will follow. When flashing, press ▼ or ▲ to change sensors (1-3). Press  to move to the next option.

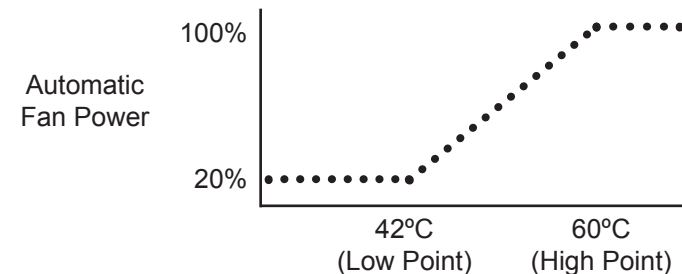
The number following “L” is the temperature low point. The number following “H” is the temperature high point. Automatic fan control will adjust fans on a dynamic ramp between these two points:



When the temperature low point is flashing, press ▼ or ▲ to adjust it. Press  to move to the temperature high point, and press ▼ or ▲ to adjust it. Press  again to return to the previous menu.

## PUMP SET

The pump speed can be manually set from 1-10:

```
PUMP (1-10) 7LV : Pump Speed Level
```

The pump speed level will flash. Press ▼ or ▲ to adjust. Press  to return to the previous menu.

## FLOW SET

If a Koolance flow meter (sold separately) has been connected to the slot interface adapter, configuration is needed to properly display its values. Only one flow meter can be displayed by the cooling system.

```
FLOW METER SET  
FM-17 ID: 10mm : Flow Meter Model, Tubing Internal Diameter
```

The Koolance flow meter model number (SKU) will flash. Press ▼ or ▲ to adjust this based on the following:

- INS-FM16: change to “FM-16”
- INS-FM17, INS-FM17N, INS-FM18: change to “FM-17”

Press  to move to the next option. The tubing internal diameter (ID) size will flash. This refers to the hose size attached to the flow meter itself. Press ▼ or ▲ to adjust this based on the following:

- 6mm (1/4 inch): change to “ID: 6mm”
- 10mm (3/8 inch): change to “ID: 10mm”
- 13mm (1/2 inch): change to “ID: 13mm”

Press  to return to the previous menu.

## DISPLAY SET

The display settings configure which values you wish to appear on the front display and how they are shown:



```
DISPLAY  
FIXED CYCLIC : Show 2 values or cycle multiple values
```

The first option, “FIXED”, will flash. Press ◀ or ▶ to change between these options. Press  to configure one of the selections, or press ▲ to exit. If “FIXED” is selected, two lines will be shown:

```
TEMP1 21.7C : First line display option  
TEMP1 21.7C : Second line display option
```



The first line will flash. Press ▼ or ▲ to change what this line will display:

```
↑ TEMP1 21.7C : Show temperature sensor #1  
TEMP2 21.2C : Show temperature sensor #2  
TEMP3 20.8C : Show temperature sensor #3  
FAN1 1770RPM : Show fan channel #1  
FAN2 1640RPM : Show fan channel #2  
FAN3 1820RPM : Show fan channel #3  
PUMP 5730RPM : Show pump speed  
↓ FLOW 4.1LPM : Show flow rate
```

Press  to confirm. The second line will flash. Press ▼ or ▲ to adjust this line. Press ◀ to return to the previous menu, or press  to return to the main screen.



When “FIXED” is the chosen display option, line 1 and 2 can be changed quickly without reentering the DISPLAY SET menu. To do this, briefly press ▲ from the main screen. The first line will flash:

```
TEMP1 21.7C : First line display option  
PUMP 5400RPM : Second line display option
```

Press ▼ or ▲ to change what this line will display among the options described earlier. Press  to move to line 2, and similarly use ▼ or ▲. Press  again to exit.

If “CYCLIC” is chosen from the DISPLAY SET menu, multiple values will be rotated through the front display. The first option is whether these values will cycle vertically or horizontally through the display:

```
CYCLIC  
VERT HORI : Rotate values vertically or horizontally
```

The first option, “VERT”, will flash. Press ◀ or ▶ to change between these options, press  to configure a selection, or press ▲ to exit. Choosing either option with  will list all available values:

```
↑ *TEMP1 21.7C : Show temperature sensor #1  
*TEMP2 21.2C : Show temperature sensor #2  
*TEMP3 20.8C : Show temperature sensor #3  
*FAN1 1770RPM : Show fan channel #1  
*FAN2 1640RPM : Show fan channel #2  
*FAN3 1820RPM : Show fan channel #3  
*PUMP 5730RPM : Show pump speed  
↓ *FLOW 4.1LPM : Show flow rate
```

The selected line will flash. Use ▼ and ▲ to navigate to other lines. Press  to enable or disable each value. This will remove the asterisk, thereby hiding that line from being shown on the main screen:

▲	*TEMP1	21.7C : (shown)
	*TEMP2	21.2C : (shown)
	TEMP3	20.8C : (not shown)
	*FAN1	1770RPM : (shown)
	FAN2	1640RPM : (not shown)
	FAN3	1820RPM : (not shown)
	*PUMP	5730RPM : (shown)
▼	*FLOW	4.1LPM : (shown)

Press ◀ to return to the previous menu, or press ▶ to exit DISPLAY SET.

This page is intentionally left blank.



# Chapter 2

## Installation

### Positioning the Unit

The cooling unit is designed to operate in one orientation. In other directions, the pump and reservoir may not bleed properly and could lead to cavitation.



YES



NO

### Reservoir & Pump Connections

The rear of the unit accepts various connections to integrate with your cooling system.

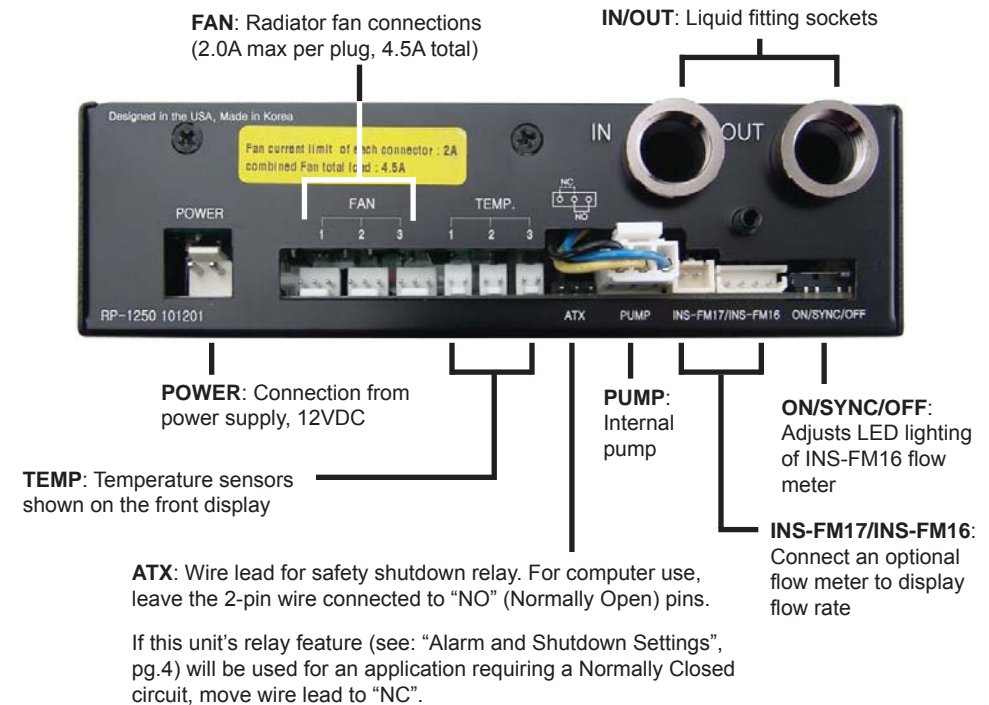

## Power Connection

The temperature sensors and ATX lead may come pre-connected to your unit. If not, connect them per the diagram on page 11.

Attach the included power harness to the location on the rear of the unit marked "Power". To this, connect a 12 Volt 4-pin Molex plug from your power supply.

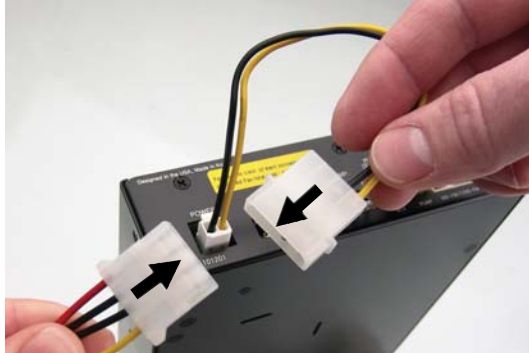

## Fan Connection

This unit has three connections to power radiator fans. Multiple fans can be combined into a single plug. (A fan wiring harness is optionally available from Koolance).

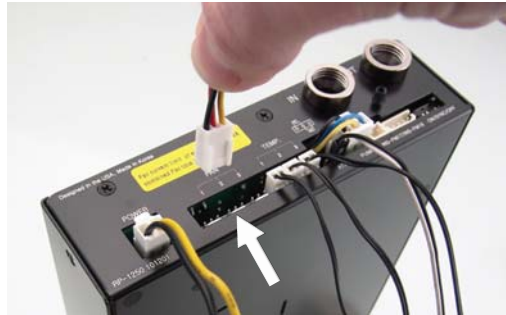

**CAUTION:** The total combined amperage of all fans connected to the unit can not exceed 4.5A. The maximum load on a single fan header is 2.0A.

## Flow Meter Connection

The cooling system can show values for one Koolance INS-FM16, INS-FM17/N, or INS-FM18 flow meter (sold separately). The use of a flow meter is optional.

Connect a flow meter to the appropriately labeled plug. (Note: INS-FM18 should connect to the plug labeled "INS-FM17".)



## ATX Pass-Through Lead

The ATX pass-through lead is responsible for sending the shut-down signal if any sensor reaches the preset shutdown temperature (See *Display Panel* for configuration).

There is no polarity direction with the ATX lead. Connect the male ATX power lead from the cooling unit to your computer's main chassis power button.

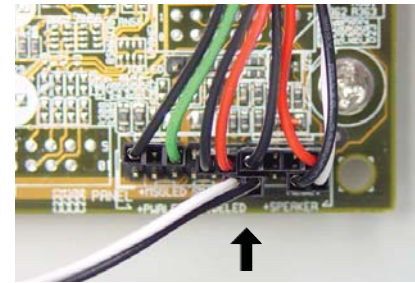
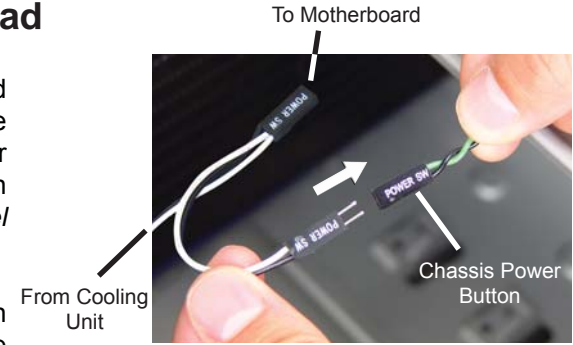

Connect the female ATX power lead from the Slot Adapter to the motherboard's power switch connection (often marked "PWRSW", "PSW", or "PWBT").

This is the connection that would normally receive the chassis power button directly.



**CAUTION:** The auto shutdown safety feature of this product will not function without properly connecting the ATX pass-through lead.

## Temperature Sensor Placement

Three surface temperature sensors are included with this product for monitoring. Generally, sensors are affixed to water blocks with metal tape. (Liquid temperature sensors are also available optionally from Koolance.)

**Sensors should never be placed directly between a heat source and its water block. This will interfere with contact and can damage the sensor or heat source.**

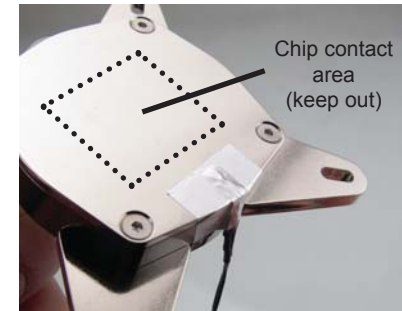

## Fittings

Install the G 1/4 BSP threaded fittings you purchased for your unit. It's recommended to hand-tighten all fittings to avoid damaging the unit.



Cut tubing into two segments. You will need to connect each to the rear fittings.

Each hose connection will use a threaded compression ring or hose clamp to keep it secure. Be sure to thread the compression ring or hose clamp onto the hose before attaching it.

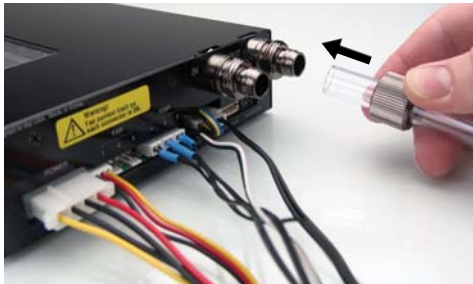

Squeeze the tube while pushing it firmly over the fitting. Tubing should completely cover the fitting.

Wetting the end of the hose with warm water can make installation much easier.

Tighten the connection by sliding the compression fitting down over the fitting and screwing securely. For hose barbs, use pliers to move it into the proper position.



## Cooler & Tubing Configuration

There are a vast number of methods for configuring a liquid cooling system (serial, parallel, combinations, alternating components, etc.). There is no single "correct" way! As long as coolant is flowing and you are satisfied with your device temperatures, it's an acceptable configuration.

Similarly, the maximum number of water blocks allowed in a system will depend upon your own configuration and thermal requirements. It's common to see five or more coolers in a Koolance system, but the limit is at what temperature you are comfortable with.

### Serial Loops

A basic serial loop is recommended for \*almost\* every situation. Provided your cooling system has a radiator of sufficient size for your total heat load, expect only a minor difference between outlet and inlet temperatures. In computer cooling, a delta of less than 1 to 3°C (1.8 to 5.4°F) is typical for the heat exchanger. This means for most loops, you don't need to worry about "hot water" moving from one block to the next. It gets only a little warmer throughout the entire loop.

Generally, series is the simplest and most effective configuration. Each device is daisy-chained to the next, usually starting with the most temperature-critical:

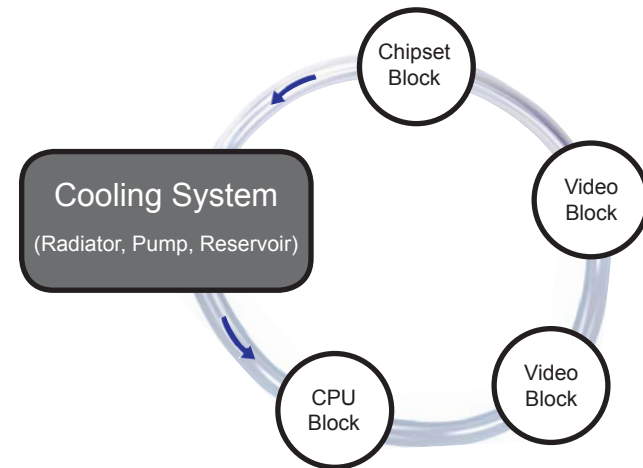

## Parallel Loops

Parallel loops are normally used to help accommodate water blocks with significantly disproportionate flow restriction. They can become quite complicated and if not well-planned, may lower performance through added bottlenecks and pressure drop.

One suggestion for parallel loops is to reduce tubing size when splitting. Ideally, the hose area going into the splitter will be roughly equal to (or slightly lower than) the combined hose area coming out. For example, 3/8" (10mm) tubing split into two 3/8" (10mm) paths would lose more pressure than splitting from 3/8" (10mm) into two or three 1/4" (6mm) paths.

If you are considering a parallel flow path, we would encourage you to experiment with different setups. There may be more optimal configurations than the example shown below.

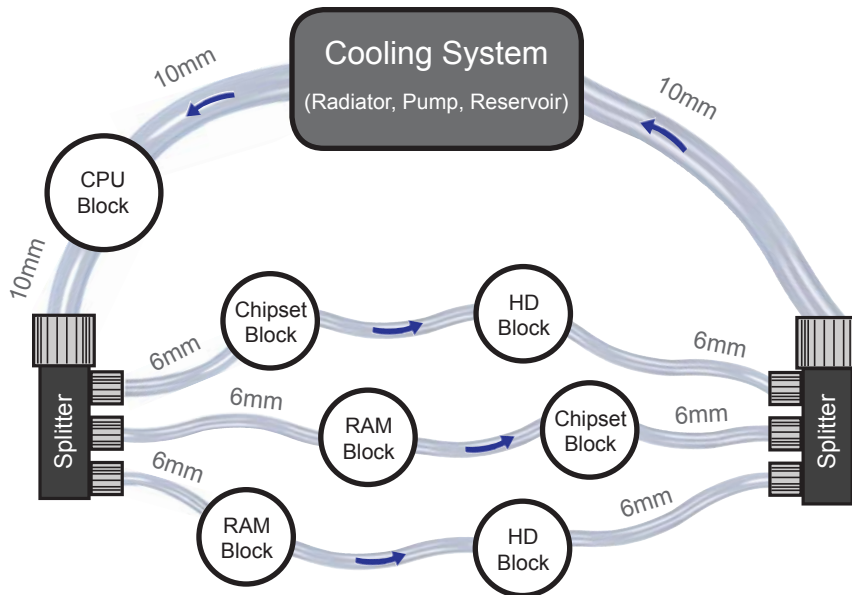

## Disconnecting Hoses

Nozzles are designed to attach tightly. If you need to remove a hose for any reason, it may not pull off easily, even after unscrewing the compression fitting.

Usually, a connection will come free by squeezing the hose *on top* of the fitting and twisting/pulling away. If this fails, cutting a small incision lengthwise (parallel) along the fitting will free it.

When a hose has been removed, it may be distorted. This last portion (about 1cm, 7/16") should be trimmed to ensure a perfect fit with the next connection. The tip should *always* be re-cut if you needed to remove the tubing with an incision.

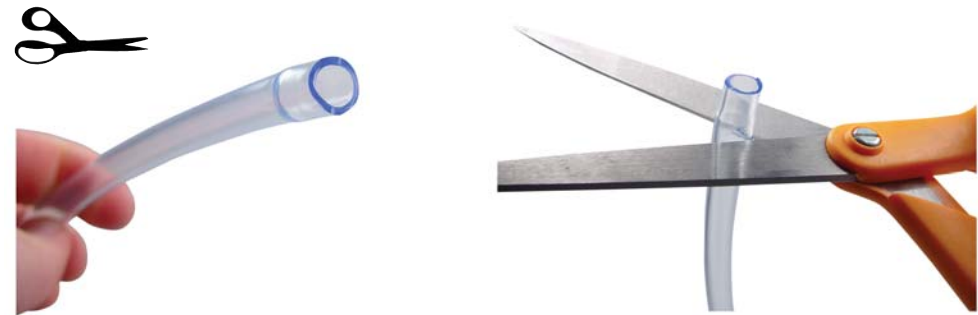

## Hose Lengths

Before installing your liquid coolers, appropriate lengths of tubing must be cut to connect each device. For computer cooling, it's generally easier to estimate the required amounts with hardware already mounted.

On the rear of the unit, the inlet and outlet locations will be labeled. Generally, the outlet will connect first with your CPU Cooler or the most temperature-sensitive device.

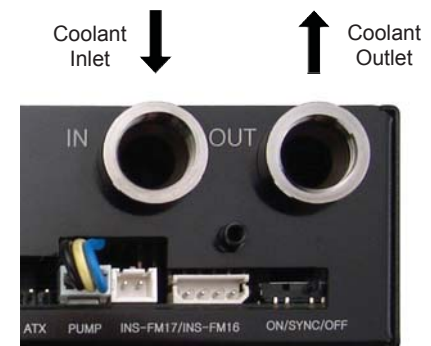





With the connected outlet hose, roughly estimate the length you will need to your first cooler, and cut it.

Cut the second hose with enough length to reach the last water block that will be in your system.

Using the leftover tubing, cut shorter pieces to link between each individual cooler.

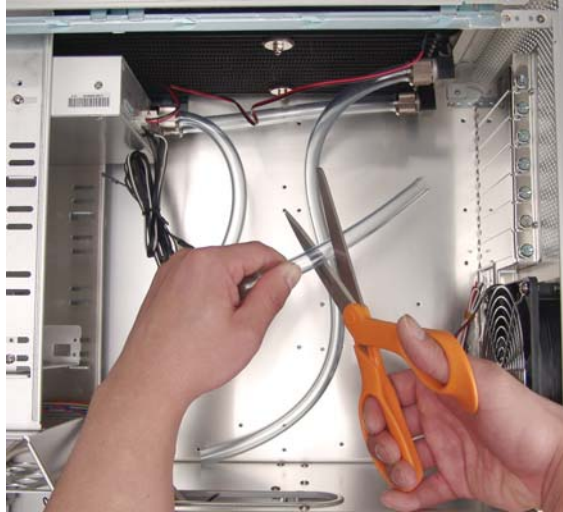

**NOTE:** When filling the reservoir later, it will need to be pulled out from the front chassis drive bay by about 2.75" (7cm). **Be sure to leave enough tubing between the reservoir unit and connected components to do this.**



Continue connecting all of your coolers in the system until there are no longer any open tube ends.

## Liquid Coolers

You should now install the liquid coolers (CPU, GPU, Hard Drive, etc.) to your hardware before continuing this User Manual. Please refer to your cooler kit's individual installation instructions, then continue on to the next section.

# Chapter 3

## *Filling & Maintenance*



**WARNING:** The cooling system's pump can not be run dry for any period of time. Never power-on the computer or cooling system without sufficient liquid in the reservoir. Dry-running (and thereby damaging the pump) is not covered under the Koolance product warranty.

## Testing & Filling

Once all the water blocks have been connected, the system can be filled with coolant. The fill port is located on top of the reservoir. Free this component by removing its side drive screws. Slowly pull it out just enough to expose the refill plug (about 2.75", 7cm).



**WARNING:** Most coolants are electrically conductive. Use caution when filling the system, and keep all liquids away from electronics and power cables. In case of emergency during installation, immediately unplug the primary AC power cable. Dry the system thoroughly before proceeding.



Slowly fill the system. **To maintain the product warranty, use only Koolance approved coolant.** Many alternative liquids and additives can cause permanent damage to the cooling unit (through chemical reaction, corrosion, biological growth, thermal expansion, viscosity, etc.).



Replace the fill port on the reservoir. **Do not overtighten the fill port.**

The cooling system should be powered on to assist in the filling process. This also allows you to check hose connections and make sure there are no tubing folds, leaks, or blockages. If cooling a computer, this can be done without powering on other hardware for extra safety (see below).



**CAUTION:** Jumping the incorrect ATX power supply pins can cause permanent damage to the power supply.

Make sure the AC power cord is attached to the power supply. If the power supply has a rear switch, it must be set to the ON (-) position. Using the included green Jumper Wire, insert the metal prongs into the **fourth and sixth** holes on the 20-24 pin ATX motherboard power supply plug as labeled below (usually green and a black ground wire; See *diagram*).

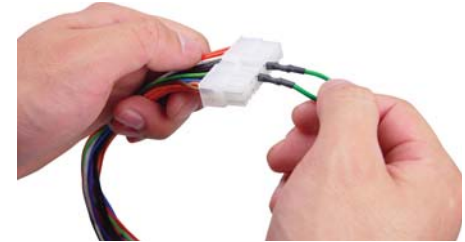
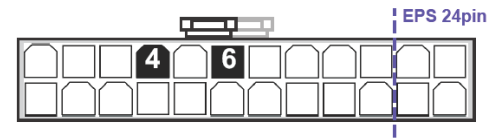

If your pump has a speed control option, set it to the lowest level during this time. Allow the pump to run until the liquid noise subsides.

During this process, cooling systems often need to be tilted gently to allow air to escape from the pump and radiator. **Until the pump is “burped” in this manner, it can cavitate and there will be no circulation.** (This does NOT indicate a problem with the pump.)

The reservoir level will decrease during this procedure. Remove the fill port cap and add more liquid when needed. If you frequently hear this rushing noise in the future, it usually indicates the need for more coolant.

That's it! Replace the ATX motherboard connection and boot-up the computer.



## Adding Coolers & Maintenance

With normal use, Koolance's liquid coolant should be replaced every 2-3 years. If it ever becomes contaminated, unclear, or significantly changes color, it should be replaced immediately. A Koolance "drain valve" (sold separately) is recommended to make that process easier.

If you are upgrading or removing a cooling block in your system, please follow the instructions below.



**CAUTION:** Any time a hose is disconnected with coolant still inside, leaking will occur. It is highly recommended to empty your cooling system of coolant before disconnecting any hoses.

Working on a liquid cooling system is much easier and safer when liquid coolant is removed beforehand. However, certain procedures can be done without removing the coolant.

A binder clamp (available at office supply stores) is helpful for keeping a hose folded while removing or adding coolers. Even so, pressure within the cooling system is such that liquid will not easily flow out unless relieved elsewhere-- for example, by opening the reservoir fill port.

Bend the hose directly before and after the section to be worked on. Place a binder clamp on both bends, or tie them in this position to help avoid fluid loss. There will be some liquid exposed; do not operate on the cooling system in this manner near or above electronic hardware.



### Radiator Performance

Over time, dust will accumulate on the radiator. While the cooling system may continue to operate in this condition, performance can decrease. To keep the system clean, check the radiator periodically (through the top fan grill) and use a can of electronics air cleaner if necessary.

## Troubleshooting

We hope your Koolance system will provide you with years of reliable cooling performance. To help avoid unnecessary RMA issues, we have prepared this list of possible operational problems, and their most common solutions.

### 1. The pump does not appear to be operating properly...

Pumps need to be "burped" during the initial bleeding process to avoid this situation. Reduce pump speed (but not low enough to stop the pump).

While the pump is running, gently tilt the system in various directions until coolant begins moving. Open the fill port to relieve excess air.

### 2. My temperatures seem too high...

Verify that the liquid coolers are making sufficient contact with each component. Ensure thermal paste has been applied (but not excessively), that the block's protective bottom film has been removed, and that the water block is positioned correctly (see the cooler's manual). Also check there are no blocks, twists, or crimps in the tubing.

Finally, a dusty Radiator can result in higher temperatures. Please see *Draining and Maintenance* for more information.

### 3. When I adjust the temperature alarm settings, it skips number increments...

This is normal operation if your display is set to display in Fahrenheit, because the temperature program is based on units Celsius. Some °C values convert to decimal temperatures in °F, or skip over them, and these can not be set by the program.

### 4. After the system has been on for awhile, the temperature alarm sounds...

Make sure the temperature is at or above your preset alarm temperature (default is 50°C, 122°F). If not, the audio alarm may be emanating from another location, such as your motherboard's BIOS alarm or video card. The Koolance temperature will flash whenever the cooling system alarm sounds.

If the alarm is produced by the Koolance unit and the display temperature has not reached the alarm preset, please contact our technical department.

Also verify that the fans and pump are operating (see Troubleshooting #1), and that liquid movement is present in the reservoir.

5. My system has boot-up problems, or does not turn on...

Make sure the ATX wire lead is connected to “NO” (Normally Open) on the rear of the unit. (See: “Reservoir and Pump Connections” for details.)

If this does not solve the issue, it is unrelated to the Koolance unit. In a computer, a problem with the RAM, motherboard, power supply, video card, processor, or monitor can cause the system to appear not to boot-up properly.

6. My system appears to be leaking fluid...

It is possible a connection was not properly sealed (however unlikely). If you can see liquid somewhere on the tubing, or at the bottom of the chassis, computer components may need to be removed for a system test (see *Testing & Filling*).

If liquid should get onto another computer component, shut down the system, and remove the component. In many cases, the hardware will be fine after allowing it to dry. However, the system should not be operated until you have discovered where the leak is coming from and can repair the problem. Should the leak be situated somewhere where it can not be easily repaired, please contact our Technical Department for further assistance.

7. My computer’s BIOS gives me errors that there is no cooling fan attached...

Some motherboards will not boot, or may generate an error or alarm if no cooling fan is attached to the CPU or motherboard chipset power connectors. There is typically an option to disable this warning in BIOS, but you may need to boot with a fan attached initially to disable this setting. If the system is not booting due to this problem, clear the CMOS and try configuring BIOS again.

8. The Display Panel shows “OPEN” for a temperature sensor...

This indicates a temperature sensor was not found for the specified channel. If there is no sensor connected to that channel, this is its normal status.

9. The front display is locked up or not responding.

This can happen if the unit is powered off within 5 seconds of being powered on. Reset the display to manufacturer defaults by holding ▼ + ▲ for 5 seconds. Three beeps will be heard to indicate the unit was reset. After a reset, all configuration settings (temperature, alarm, fans, etc.) must be updated again.

10. The flow meter reads “0”.

Make sure the Koolance flow meter you have purchased is directly connected to the back of the unit (See *Connecting the Unit*). Also be sure the correct flow meter model and tubing ID are selected via the front display (See *Display Panel*).

## Limited Warranty

**Koolance Incorporated (“Koolance”) warrants each new Koolance liquid-cooled system (“the system”), against defects in materials or workmanship for a period of one year from the date of purchase, and agrees to repair or replace any defective Koolance system without charge. Shipping costs are non-refundable.**

This warranty is non-transferable. All warranty claims must be accompanied by the original proof of purchase.

THIS WARRANTY DOES NOT COVER DAMAGE RESULTING FROM ACCIDENT, MISUSE OR ABUSE, LACK OF REASONABLE CARE, SHIPPING DAMAGE, MODIFICATIONS, THE AFFIXING OF ANY ATTACHMENT NOT PROVIDED WITH THE PRODUCT, LOSS OF PARTS, OR OPERATING COMPONENTS AT SPEEDS OR FUNCTIONS OTHER THAN THOSE SPECIFIED BY THEIR MANUFACTURERS.

Use of unauthorized replacement parts or liquids will void this warranty. Koolance Incorporated will not pay for warranty service performed by a non-authorized repair or diagnostic service and will not reimburse the consumer for damage resulting from warranty service performed by a non-authorized repair service. No responsibility is assumed for any special incidental or consequential damages due to a defective Koolance product.

In order to obtain warranty service, contact our RMA department for information. The product must be shipped postage prepaid to an authorized Koolance service location. It is suggested that, for your protection, you return shipments of product by insured mail, insurance prepaid. Damage occurring during shipment is not covered by this warranty. Shipping costs are non-refundable. No other warranty, written or oral, is authorized by Koolance Incorporated.

## Disclaimer

IN NO EVENT SHALL KOOLANCE INCORPORATED OR ITS EMPLOYEES, AGENTS, SUPPLIERS, MANUFACTURERS, OR CONTRACTORS BE LIABLE FOR ANY DAMAGES OF ANY KIND OR CHARACTER, INCLUDING WITHOUT LIMITATION ANY COMPENSATORY, INCIDENTAL, DIRECT, INDIRECT, SPECIAL, PUNITIVE, OR CONSEQUENTIAL DAMAGES, LOSS OF USE, LOSS OF DATA, LOSS OF INCOME OR PROFIT, LOSS OF OR DAMAGE TO PERSONS OR PROPERTY, CLAIMS OF THIRD PARTIES, OR OTHER LOSSES OF ANY KIND OR CHARACTER, AND WHETHER OR NOT THE POSSIBILITY OF SUCH LOSS OR DAMAGE HAS BEEN NOTIFIED TO KOOLANCE INCORPORATED.